

Getting Started Guide

PCEye 5



tobii dynamox

What's in the box?

- 1 PCEye 5
- 2 Getting Started Guide
- 3 Mount Plate
- 4 Mount Plate Prep Kit
- 5 Safety and Compliance Document
- 6 Carry Case
- 7 USB-C to USB-A Adapter

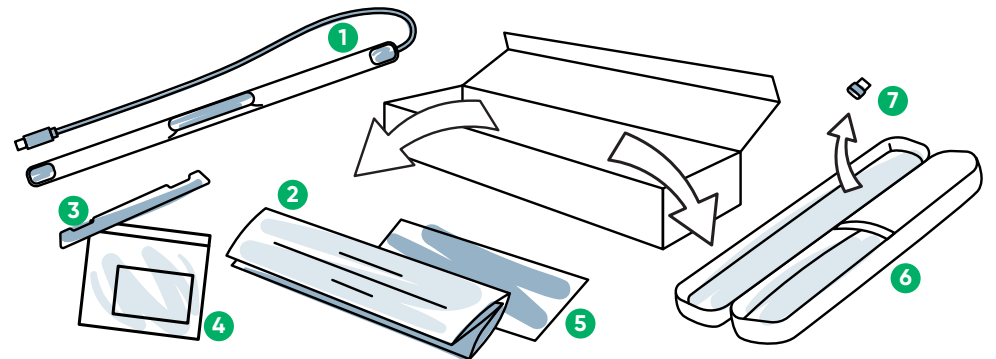

Software

PCEye 5 includes the Computer Control Software. If you purchased the Magic EyeFx bundle, please see the license card for more information.

Getting to Know Your Device

- 1 Eye Tracker
- 2 USB Connector
- 3 Installation Markings
- 4 Mounting Magnets

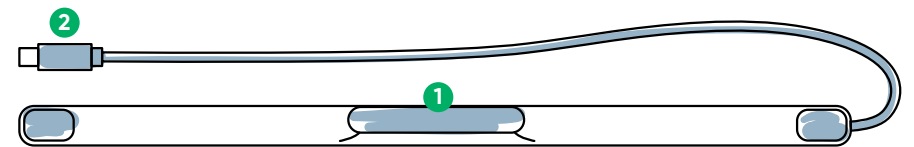

Front

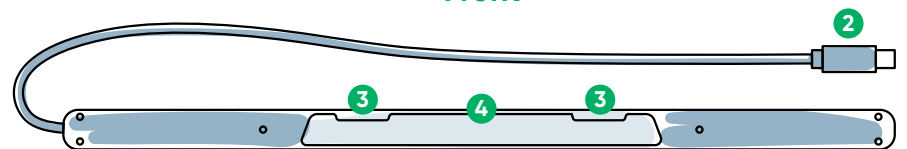

Back

We Are Here to Help



Resources

Discover Tobii Dynamox App:
<http://qrco.de/TDDiscover>

User Manual:
<http://qrco.de/PCEyeManual>



Additional Support

Community:
<http://qrco.de/TDFB>

North America Technical Support:
1-800-344-1778 ext. 1

Additional
PCEye 5
resources
are
available
here:



#PowerToBeYou

Share your PCEye 5 unboxing and
first use photos and videos with
#PowerToBeYou.

Getting Setup

Complete the three steps in this guide to download the required software and mount the PCEye 5 device to your computer. Downloading the software **FIRST** will provide onscreen instructions and walk you through the steps for set up and use.

i You can use the PCEye 5 on a laptop or desktop computer.

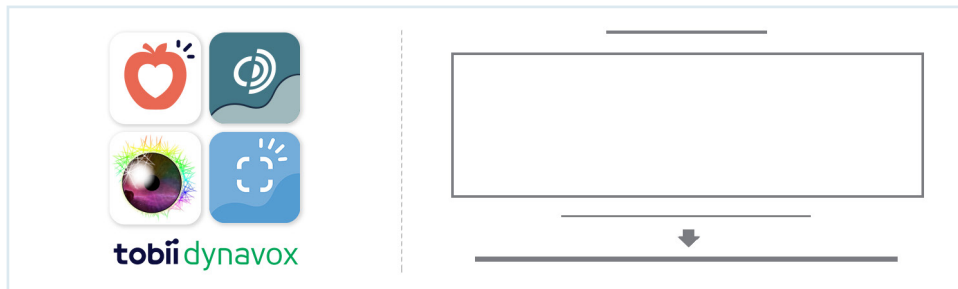

Step 1: Download PCEye 5 Software

Go to <https://qrco.de/PCEyeCC> and download PCEye 5 Software.

Step 2: Mount PCEye 5 & Calibrate

i If using the PCEye 5 with the optional PCEye 5 Bracket, skip this step and see included instructions for detailed information.

Follow the onscreen prompts. Return to guide for more information about the software.

Step 3: Launch Software

If you purchased a software bundle or received additional license cards, follow the download and installation instructions on each card (see left).

Getting Started with Computer Control Software

Paired with the PCEye 5, Computer Control will give you access to mouse and keyboard functions. When Computer Control is opened for the first time, the Quick Start Guide will provide an overview of the different actions.

i You can return to the Quick Start Guide by selecting the Information button.

Select Hide Screen to exit.



Explore the Trace

The Trace will give you feedback about where you are looking on the screen. When you fixate on an item, the Activator button will appear. Fixating on the Activator button will open the Interactions Menu.

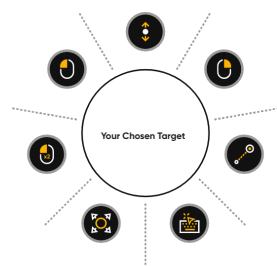

Explore Interactions Menu

The Interactions Menu provides access to the keyboard and primary mouse functions.

i For detailed description of each function, please see the User Manual.

Explore the Off-Screen Menu

The Off-Screen Menu gives you access to Continuous Click, Settings, and Pause. To access this menu, fixate your gaze to the center of the PCEye 5.



To recalibrate, access the Off-Screen Menu, select More, then select Quick Calibrate.

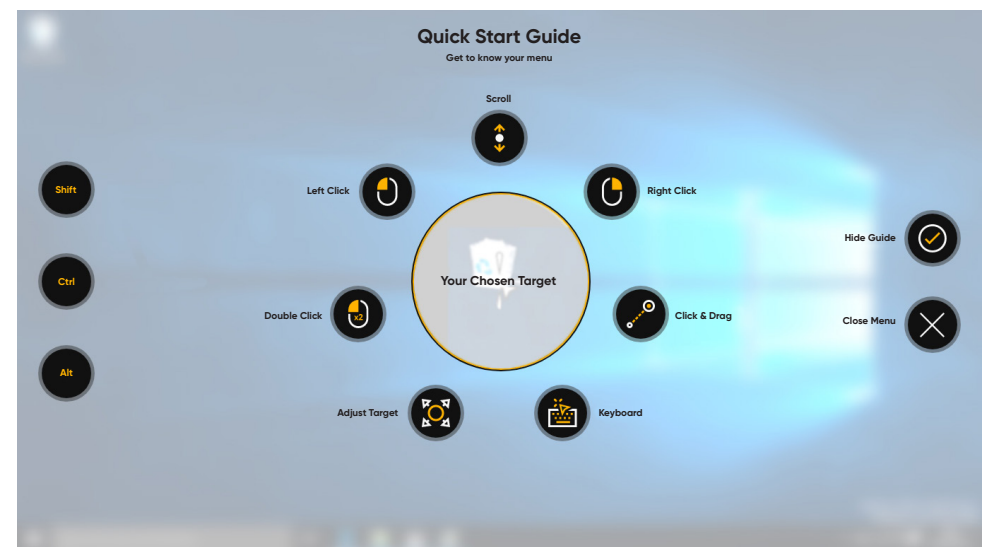

i As you explore Computer Control, it is OK to recalibrate if your accuracy is not optimal.



Helpful Tips for Using Computer Control

- Use Pause when you need to rest your eyes.  **Pause**
- The desired item doesn't need to be perfectly placed in the center of the Trace.
- To increase accuracy, use Adjust Target.  **Adjust Target**
- When using Scrolling, the further away from the scroll icon your eyes are looking, the faster the scroll will go. Scroll works up and down and side to side.
- For typing into text fields, place the Trace in the text field, then select Keyboard. No left click is required.