

Tobii Dynavox EyeMobile Plus User's Manual



User's manual Tobii Dynavox EyeMobile Plus

Version 1.2

05/2018

All rights reserved.

Copyright © Tobii AB (publ)

No part of this document may be reproduced, stored in a retrieval system, or transmitted in any form, by any means (electronic, photocopying, recording, or otherwise) without the prior written permission of the publisher.

Copyright protection claimed includes all forms and matters of copyrightable material and information allowed by statutory or judicial law or hereafter granted, including without limitation, material generated from the software programs which are displayed on the screen such as screen displays, menus, etc.

The information contained in this document is proprietary to Tobii Dynavox. Any reproduction in part or whole without prior written authorization by Tobii Dynavox is prohibited.

Products that are referred to in this document may be either trademarks and/or registered trademarks of the respective owners. The publisher and the author make no claim to these trademarks.

While every precaution has been taken in the preparation of this document, the publisher and the author assume no responsibility for errors or omissions, or for damages resulting from the use of information contained in this document or from the use of programs and source code that may accompany it. In no event shall the publisher and the author be liable for any loss of profit or any other commercial damage caused or alleged to have been caused directly or indirectly by this document.

Content subject to change without notice.

Please check Tobii Dynavox web site

www.TobiiDynavox.com for updated versions of this document.

Contact Information:

Tobii Dynavox	Tobii Dynavox LLC
Karlsrovägen 2D	2100 Wharton Street Suite 400
182 53 Danderyd	Pittsburgh, PA 15203
Sweden	USA
+46 8 663 69 90	+1-800-344-1778

The EyeMobile Plus is protected by the following U.S. Patents:

- 7.572.008
- 6.659.611

Table of Contents

1	Introduction.....	5
1.1	Explanation of Admonitions.....	5
1.2	Intended Use	5
1.3	Package Contents.....	6
2	Safety	7
2.1	Avoiding Hearing Damage	7
2.2	Power Supply and Batteries.....	7
2.3	Mounting.....	8
2.4	Epilepsy Warning	8
2.5	Infrared Warning	8
2.6	Magnetic Field Warning	8
2.7	Child Safety.....	9
2.8	Do not open EyeMobile Plus	9
2.9	Emergency	9
2.10	Windows Control.....	9
2.11	Third Party.....	9
2.12	Environmental Control.....	9
3	Getting Started with EyeMobile Plus	10
3.1	Requirements	10
3.2	Overview.....	11
4	Batteries in the EyeMobile Plus	12
4.1	Batteries	12
4.2	Charging the EyeMobile Plus	12
4.2.1	Checking Charge Level.....	12
4.2.2	Power LED Behavior.....	12
5	Using EyeMobile Plus.....	13
5.1	Positioning the User.....	13
5.2	Infrared Remote (IR)	13
5.2.1	Sending IR Signals.....	14
5.2.2	Programming IR Signals.....	14
6	Settings	15
6.1	Microphone Settings	15
6.2	Switch Settings.....	15
6.3	Setup Windows Hello.....	15
7	Applicable Application Software	16
8	Product Care	17
8.1	Temperature & Humidity	17
8.1.1	General Use	17
8.1.2	Transportation and Storage	17
8.2	Cleaning	17
8.3	Transporting the EyeMobile Plus	17
8.4	Disposing of the EyeMobile Plus	17
Appendix A	Support and Warranty	18
A1	Customer Support.....	18
A2	Warranty.....	18

Appendix B Compliance Information 19

- B1 FCC Statement.....19
- B2 Industry Canada Statement19
- B3 CE Statement19
- B4 Other Directives19
- B5 Standards19

Appendix C Technical Specifications..... 21

1 Introduction

Thank you for purchasing an EyeMobile Plus device from Tobii Dynavox!

To ensure the optimal performance of this product, please take the time to read this manual carefully.

1.1 Explanation of Admonitions

In this manual we use four (4) levels of admonitions as follows:



The Note symbol is used for notifying the user of something important or of something that needs special attention.



The Caution symbol is used to inform of something that could cause harm to, or malfunction of, the equipment.



The Warning symbol is used to inform of something in which there is a conceivable risk of harm to the user if the Warning is ignored.



The High Volume symbol is used to inform of something that can cause damage to hearing.



The High Temperature symbol is used to inform of surface temperature conditions that may cause injury or discomfort.

1.2 Intended Use

The EyeMobile Plus is our integrated mobile solution for computer access purposes as an alternative input device to the keyboard and mouse for people that have challenges in their ability to access a computer due to injury, disability or illness. With a built in Eye tracker, IR, switches, microphone array, battery, great speakers and together with a Windows tablet you are ready to go out in the world. No matter if you want to use it as an always connected computer access solution or if you want to use it as a Speech Generating solution, with an EyeMobile Plus you are really ready To Go!

The EyeMobile Plus includes an eye tracker that lets you access and control your Windows Tablet using only your eyes. Simply look at the tablet and select commands by dwelling, zooming and/or clicking a switch. Alternatively, fully control the mouse cursor directly with your eye movements.

The EyeMobile Plus is intended to be used with Windows Control for Augmentative and Alternative Communication (AAC) and/or for computer access purposes as an alternative input device to the keyboard and mouse for people that have challenges in their ability to speak and/or access a computer due to injury, disability or illness.

The EyeMobile Plus is not intended solely as an eye tracking device, but also includes other input and output methods. There is a microphone array built in which is intended to be used together with a number of different speech recognition software to allow the user to dictate speech and use their voice to assist in controlling the computer. The EyeMobile Plus also contains switch ports that are intended to be connected to one or more switches that can assist a user with limited mobility in the control of the software on the device. The EyeMobile Plus can also be used for environmental control using infrared transmission in cases such as the control of Televisions, music devices, windows, etc.

The EyeMobile Plus works together with Microsoft Windows Hello and can be configured to make use of Windows Hello's biometric facial recognition log in.

Except for installation, the EyeMobile Plus is operated mainly by the user only by using their eyes, and it is calibrated against each user's eye movements. The intention with the EyeMobile Plus is to allow the user to control a computer, but it is not intended for the control of any other medical devices.

The EyeMobile Plus gives you a fast, accurate and hands free way of accessing the many ways a computer can enrich your life

and bring greater personal independence. You can pursue your interests and education, re-enter the workplace, stay in touch with friends and family, express yourself artistically and creatively, and stay entertained.



Figure 1.1 EyeMobile Plus



Do not cover the front of the EyeMobile Plus in any way (with decorations, Post-Its, etc.) as Windows Control will be compromised.



Using an antivirus program is strongly recommended.

1.3 Package Contents

- EyeMobile Plus
- Mounting Instruction
- USB Extension Cable
- Power Adapter



Only use the items included in the EyeMobile Plus package, those described in the product documentation and other approved Tobii Dynavox Accessories in conjunction with the EyeMobile Plus.

2 Safety

The EyeMobile Plus device has been tested and approved as compliant to all the Specifications and Standards listed in *Appendix B Compliance Information, page 19*. Nevertheless, in order to ensure safe operation of your EyeMobile Plus device, there are a few safety warnings to bear in mind:



No modification of this equipment is allowed



The EyeMobile Plus is not to be used as a life supporting Device, and it shall not be relied on in case of loss of function due to power loss or other causes.



There could be a choking hazard risk if small parts detach from the EyeMobile Plus device.



The EyeMobile Plus device shall not be exposed to or used in rain or weather conditions outside the Technical Specification of the EyeMobile Plus device.



Young children or people with cognitive disabilities should not have access to, or the use of, the EyeMobile Plus device without parental or guardian supervision.



The EyeMobile Plus device shall be used with care when moving around.

2.1 Avoiding Hearing Damage



Permanent hearing loss may occur if earphones, headphones or speakers are used at high volume. To prevent this, the volume should be set to a safe level. You can become desensitized over time to high sound levels which may then sound acceptable yet still could be damaging your hearing. If you experience symptoms such as ringing in your ears, please lower the volume or stop using the earphones/headphones. The louder the volume, the less time is required before your hearing could be affected.

Hearing experts suggest the following measures to protect your hearing:

- Limit the amount of time you use earphones or headphones at high volume.
- Avoid turning up the volume to block out noisy surroundings.
- Turn the volume down if you cannot hear people speaking near you.

To establish a safe volume level:

- Set your volume control at a low setting.
- Slowly increase the sound until you can hear it comfortably and clearly, without distortion.

2.2 Power Supply and Batteries



The EyeMobile Plus device contains a rechargeable battery. All rechargeable batteries degrade over time. Thus the possible usage times for the EyeMobile Plus after a full charge can become shorter over time than when the device was new.











The EyeMobile Plus device uses a Li-ion Polymer battery.

If you are in a hot environment, be aware that it can affect the ability to charge the battery. The internal temperature has to be between 0 °C/32 °F and 45 °C/113 °F for the battery to charge. If the internal battery temperature raises above 45 °C/113 °F the battery will not charge at all.

Move the EyeMobile Plus device to a cooler environment to let the battery charge properly.



Avoid exposing the EyeMobile Plus device to fire or to temperatures above 60 °C/140 °F. These conditions may cause the battery to malfunction, generate heat, ignite or explode. Be aware that it is possible, in a worst case scenario, for temperatures to reach greater than those stated above in, for example, the trunk of a car on a hot day. So, storing the EyeMobile Plus device, in a hot car trunk could conceivably lead to a malfunction.

-  Only charge the EyeMobile Plus battery in an ambient temperature of 0 °C/32 °F to 45 °C/113 °F.
-  Use only the supplied power adapter to charge the EyeMobile Plus device. Using unauthorized power adapters may severely damage the EyeMobile Plus device.
-  For safe operation of the EyeMobile Plus device, use only charger and accessories approved by Tobii Dynavox.
-  Do not open, or modify, the casing of the EyeMobile Plus device or of the power supply, since you may be exposed to potentially hazardous electrical voltage. The device contains no serviceable parts. If the EyeMobile Plus device or its accessories are mechanically damaged, **do not to use them**.
-  If the battery is not charged and the EyeMobile Plus is not connected to the power supply, the EyeMobile Plus device will shut down.
-  If the Power Supply Cord is damaged it needs to be replaced by Service Personnel only. Do not use the Power Supply Cord until replaced.
-  Special regulations apply to shipping devices containing Li-ion Polymer batteries. If dropped, crushed, or short-circuited, these batteries can release dangerous amounts of heat and may ignite, and are dangerous in fires. Please reference IATA regulations when shipping lithium metal or lithium ion batteries or cells: http://www.iata.org/whatwedo/cargo/dangerous_goods/Pages/lithium_batteries.aspx
-  The Power adapters shall not be used without an adult or Caregiver supervision.

2.3 Mounting

-  The EyeMobile Plus should be mounted according to the instructions of the approved mounts used. Tobii Dynavox or its agents are not liable for damage or injuries to a person or its property due to a EyeMobile Plus falling from a mounted configuration. The mounting of a EyeMobile Plus is done entirely at the user's own risk.

2.4 Epilepsy Warning

-  Some people with **Photosensitive Epilepsy** are susceptible to epileptic seizures or loss of consciousness when exposed to certain flashing lights or light patterns in everyday life. This may happen even if the person has no medical history of epilepsy or has never had any epileptic seizures.

A person with Photosensitive Epilepsy would also be likely to have problems with TV screens, some arcade games, and flickering fluorescent bulbs. Such people may have a seizure while watching certain images or patterns on a monitor, or even when exposed to the light sources of an eye tracker. It is estimated that about 3-5% of people with epilepsy have this type of Photosensitive Epilepsy. Many people with Photosensitive Epilepsy experience an "aura" or feel odd sensations before the seizure occurs. If you feel odd during use, move your eyes away from the eye tracker.

2.5 Infrared Warning

-  When activated, the EyeMobile Plus emits pulsed infrared (IR) light. Certain medical devices are susceptible to disturbance by IR light and/or radiation. Do not use the EyeMobile Plus when in the vicinity of such susceptible medical devices as their accuracy or proper functionality could be inhibited.

2.6 Magnetic Field Warning

-  The EyeMobile Plus Magnetic Mounting contains magnets. Magnetic fields may interfere with the function of cardiac pacemakers and implantable cardioverter-defibrillators. As a general rule, maintain a minimum distance of 6 inches (15 centimeters) between any item with magnets and your heart device.

2.7 Child Safety



The EyeMobile Plus is an advanced computer system and electronic device. As such it is composed of numerous separate, assembled parts. In the hands of a child certain of these parts have the possibility of being separated from the device, possibly constituting a choking hazard or another danger to the child.

Young children should not have access to, or use, the device without parental or guardian supervision.

2.8 Do not open EyeMobile Plus



Non-compliance will result in loss of Warranty! There are no user serviceable components inside. Contact Tobii Dynavox Support if your EyeMobile Plus is not working properly.

2.9 Emergency



Do not rely on the device for emergency calls or banking transactions. We recommend having multiple ways to communicate in emergency situations. Banking transactions should only be carried out with a system recommended by, and approved according to the standards of, your bank.

2.10 Windows Control



Some people may experience a certain amount of fatigue (due to intentional eye focusing and hard concentration) or even a dryness of the eyes (due to less frequent blinking) when first getting used to Windows Control. If you are experiencing fatigue or dry eyes start off slowly and limit the length of your Windows Control sessions to your comfort level. Remoisturizing eye drops can be helpful to combat dryness.

2.11 Third Party



Any use of the EyeMobile Plus outside the intended use and together with any third party software or hardware that changes the intended use is a risk and nothing that Tobii Dynavox can take any responsibility for.

2.12 Environmental Control



The Programmable IR Remote Control — Environmental Control Unit (ECU) is not to be relied on as the only method of interaction with IR controlled devices.

3 Getting Started with EyeMobile Plus

3.1 Requirements

For EyeMobile Plus we recommend the following minimum system requirements:

Component	Requirements
Computer and processor	2.0 gigahertz (GHz) or faster, Dual-Core processor (recommended minimum).
Memory (RAM)	4 gigabyte (GB) RAM (recommended minimum).
Hard Disk	450 megabytes (MB) available
USB	USB 2.0
Operating System	<ul style="list-style-type: none">• Windows 7 (64-bit)• Windows 8.1 (32-bit or 64-bit)• Windows 10 (32-bit or 64-bit)
.NET version	4.5
Tobii Eye Tracking Core Software	Version 2.8 or later



To be able to use the EyeMobile Plus, one of the following Tobii Dynavox software must be installed:

- Tobii Dynavox Windows Control
- Tobii Dynavox Gaze Point

3.2 Overview

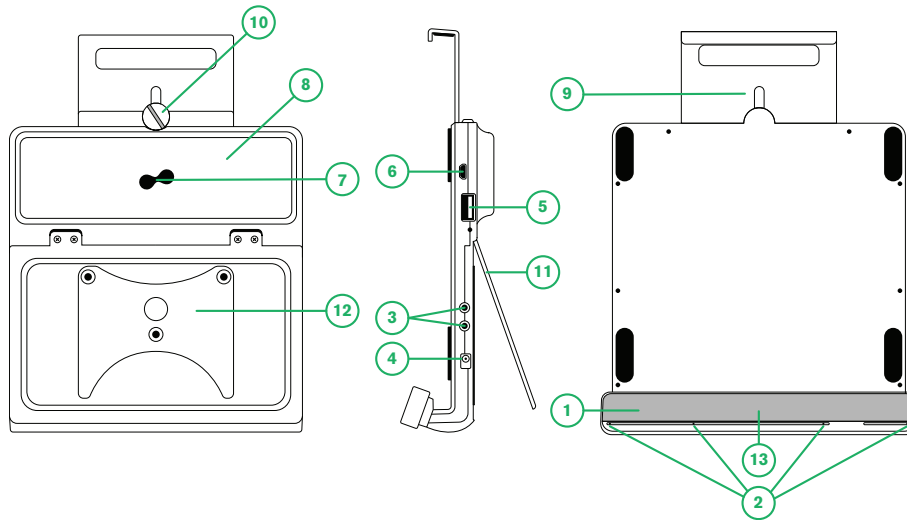

Figure 3.1 EyeMobile Plus

1	Eye Tracker	8	Speakers
2	Microphones (array)	9	Adjustment bracket
3	Switch port	10	Adjustment knob
4	Power connector	11	Stand
5	USB connector	12	Mounting bracket
6	Micro USB Connector	13	Infrared Remote (IR) Receiver
7	Infrared Remote (IR)		



Never force a connector into a port. If the connector and port do not join with reasonable ease, they probably do not match. Make sure that the connector matches the port and that you have positioned the connector correctly in relation to the port.

Be extra careful with the USB connectors.

4 Batteries in the EyeMobile Plus

4.1 Batteries

The EyeMobile Plus device has one built-in battery. Microsoft Windows gives battery warnings at certain levels. If the EyeMobile Plus device is not charged or powered up by the power supply, the EyeMobile Plus device will shut down automatically. For more information, see *Appendix C Technical Specifications, page 21*.

4.2 Charging the EyeMobile Plus

1. Connect the Power cable to the Power Connector on the device.
2. Connect the Power adapter to an electrical outlet and charge the tablet until the battery is fully charged.

If the battery charging level will drop below 5% the EyeMobile Plus will be charged over the USB connection to the tablet until the EyeMobile Plus battery reaches 10% of the charging level. With this charging behavior, the tablet and EyeMobile Plus will run out of battery at the same time.

For battery storage and charging temperatures, see *2 Safety, page 7*.

4.2.1 Checking Charge Level

To check the battery charge level of the EyeMobile Plus, use the battery monitor within Windows 10.

4.2.2 Power LED Behavior

The Power LED will shine with multiple colors:

LED state	Connection	Charge status
Solid green	USB & AC	Fully charged
Flashing green	USB & AC	Charging from AC
Solid purple	USB only	Not charging (>10%)
Flashing purple	USB only	Charging from USB (<5%)
Solid Orange	AC only	Fully charged
Flashing Orange	AC only	Charging from AC
Solid red	Unknown/Error	Unknown/Error
Off	Not connected	N/A

5 Using EyeMobile Plus

5.1 Positioning the User

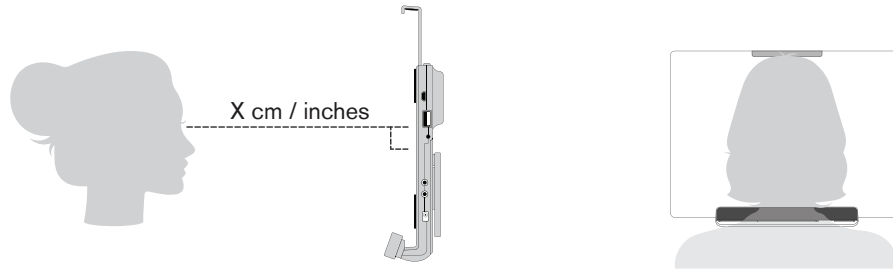

Figure 5.1 Positioning

The EyeMobile Plus is designed to work optimally when it is parallel to the user's eyes at a distance from about 45 — 85 cm (18 to 33 inches), see *Figure 5.1 Positioning, page 13* or *Figure 5.2 Positioning for Users Leaning Sideways or Lying Down, page 13*.

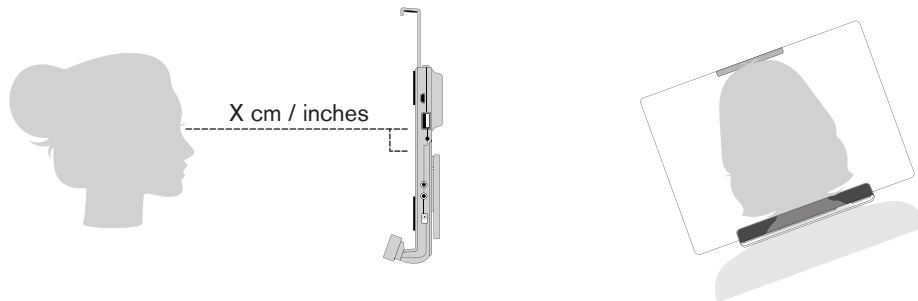

Figure 5.2 Positioning for Users Leaning Sideways or Lying Down

This means that for those users leaning sideways or those lying down the EyeMobile Plus also needs to be tilted in order to keep the users eyes parallel to the screen and at the optimal distance, see *Figure 5.2 Positioning for Users Leaning Sideways or Lying Down, page 13*.

i Make sure the user is placed comfortably in relation to the optimal positioning of, and distance from, the unit. Be aware also that the user's comfort, as well as the Windows Control performance, will be enhanced if the sun is not shining directly on the screen or into the user's eyes.

The optimal distance that a user should be from the EyeMobile Plus mounted on a monitor/laptop differs depending on the size of the screen. The user should be positioned at the optimal distance to allow for the best possible Windows Control.

Generally, the larger the size of the screen, the greater the distance the user should be from the Eye Tracker / Screen combination for optimal Tobii Dynavox Windows Control usage.

Monitors larger than up to the maximum screen size limitation should not be used for optimal Tobii Dynavox Windows Control usage, for more information see *Appendix C Technical Specifications, page 21*.

5.2 Infrared Remote (IR)

To be able to use the IR on the EyeMobile Plus you will need to use either Tobii Dynavox Virtual Remote or Tobii Dynavox Communicator 5. For more information on how to use and program the Tobii Dynavox Virtual Remote or Tobii Dynavox Communicator 5, see the User's manual for respective software.

5.2.1 Sending IR Signals

The IR transmitter, for sending, is located on the back of the EyeMobile Plus device, see position 7 in *Figure 3.1 EyeMobile Plus, page 11*. Make sure to point the backside of the EyeMobile Plus in the direction of the device you want to control with the IR.

5.2.2 Programming IR Signals

The IR Receiver, for programming, is located on the front of the EyeMobile Plus device, see position 13 in *Figure 3.1 EyeMobile Plus, page 11*. Make sure to point the remote control, which signals you want the Tobii Dynavox Virtual Remote or Tobii Dynavox Communicator 5 to learn, towards the front side of the EyeMobile Plus.

6 Settings

6.1 Microphone Settings



The EyeMobile Plus Microphone array will be set to the default microphone in Microsoft Windows during installation of the Tobii Dynavox Windows Control Software.

You can setup the built-in microphone array using the **Microsoft Windows Control Panel > Sound > Recording**.



We refer to Microsoft's information on how to configure the microphone array in the Microsoft Windows Control Panel.

6.2 Switch Settings

The built in switch ports on the EyeMobile Plus are intended to be used with one 3.5 mm switch connected directly to one of the two (2) switch ports on the EyeMobile Plus. The switch ports are by default configured as "Joystick 1" and "Joystick 2" in Windows.

The switch functionality is enabled within the different applicable application software.

1. Connect the first switch to one of the switch ports on the EyeMobile Plus.
2. If two (2) switches are needed, connect the second switch to the second switch port on the EyeMobile Plus.

6.3 Setup Windows Hello



Only works with Windows 10.

1. Open the **Windows Start** menu.
2. Select your **Account**.
3. Select **Change Account Settings**.
4. Select **Sign-in options**.
5. To proceed, set up a PIN code.
6. Select the **Add** button under **PIN** and follow the next steps.



Once you've done that the options to set up Windows Hello will unlock.

7. After successfully selecting a PIN, you'll be able to select **Set Up** under **Windows Hello** and **Face Recognition**.
8. If you'd like to get some more detailed background information on **Windows Hello** select **Learn more about Windows Hello**. Or just select **Get Started** to continue.
9. The camera in the eye tracker will now help you position yourself in front of the screen by showing a livestream through the camera. After positioning yourself successfully in front of the camera, the face recognition setup will begin automatically.
10. Once you've successfully completed the set up, an option to **Improve Recognition** will be available.



This can be quite useful if you wear glasses as it allows you to be recorded with or without them.

7 Applicable Application Software

The EyeMobile Plus has a number of different uses depending on the user's need and the application software installed.

See www.tobiidynavox.com to find support and documentation for the different compatible software.

8 Product Care

8.1 Temperature & Humidity

8.1.1 General Use

The EyeMobile Plus is best kept in dry conditions at room temperature. The recommended range for temperature and the humidity value for the device is as follows:

- Temperature: 10°C to 35°C (50°F to 95°F)
- Humidity: 20% to 80% (relative humidity, no condensation on the device)

8.1.2 Transportation and Storage

For transportation and storage the recommended range for temperature and the humidity value for the device is as follows:

- Temperature: -20°C to 60°C (-4°F to 140°F)
- Humidity: 20% to 80% (relative humidity, no condensation on the device)

The EyeMobile Plus is not waterproof or water resistant. The device should not be kept in excessively humid, damp or otherwise wet conditions. Do not submerge the device in water or in any other liquid. Be careful not to allow liquids to be spilled upon the device.

8.2 Cleaning

Before cleaning the EyeMobile Plus device shut down the computer to which it is attached and unplug all cables. Use a soft, slightly damp, lint-free cloth. Avoid getting moisture in openings on the device. Don't use window cleaners, household cleaners, aerosol sprays, solvents, alcohol, ammonia, or abrasives to clean the device.

It is recommended that the device be cleaned regularly.

8.3 Transporting the EyeMobile Plus

Disconnect the USB cable and use the carrying case accessory. The EyeMobile Plus is relatively fragile and the filter can be scratched if not properly protected; be sure to take precautions to protect the device when it is to be carried and packed.

When you transport the device for repair, shipment or traveling, use the original casing and packaging materials.



When the EyeMobile Plus is attached to a monitor/laptop, do not carry the connected devices by solely gripping the EyeMobile Plus. The EyeMobile Plus will not hold the weight of the monitor/laptop, and the devices could break apart and fall, or topple and fall because of misbalanced weight, causing permanent damage to both. Tobii Dynavox will not be held liable for the resulting damage.

8.4 Disposing of the EyeMobile Plus

Do not dispose of the EyeMobile Plus in general household or office waste. Follow your local regulations for the disposal of electrical and electronic equipment.

Appendix A Support and Warranty

A1 Customer Support

For support, please contact your local representative or Tobii Dynavox Support. In order to receive assistance as quickly as possible, make sure you have access to your EyeMobile Plus and, if possible, an Internet connection. You should also be able to supply the serial number of the device, which you find on the back of the device. Find our Support pages online at: www.tobiidynavox.com or www.myTobiiDynavox.com.

A2 Warranty

Please read the Manufacturer's Warranty paper included in the package.

Please read this User's Manual carefully before using the device. The warranty is only valid if the device is used according to the User's Manual. Disassembling the EyeMobile Plus device will void the warranty.



It is recommended to keep the original packaging materials for the EyeMobile Plus.

If device needs to be returned to Tobii Dynavox for Warranty related issues or repair, it is beneficial that the original packaging or equal equivalent is used for shipping. Most shipping carriers require at least 2 inches of packing material around the device.

Note: Due to Joint Commission regulations, any shipping materials including boxes sent to Tobii Dynavox must be discarded.

Appendix B Compliance Information



The EyeMobile Plus is CE-marked, indicating compliance with the essential health and safety requirements set out in European Directives.

B1 FCC Statement

This device complies with Part 15 of the FCC Rules. Operation is subject to the following two conditions: (1) this device may not cause harmful interference, and (2) this device must accept any interference received, including interference that may cause undesired operation.



Modifications not expressly approved by Tobii Dynavox could void the user's authority to operate the equipment under FCC rules.

This equipment has been tested and found to comply with the limits for a Class B digital device, pursuant to part 15 of the FCC Rules. These limits are designed to provide reasonable protection against harmful interference in a residential installation. This equipment generates, uses and can radiate radio frequency energy and, if not installed and used in accordance with the instructions, may cause harmful interference to radio communications.

However, there is no guarantee that interference will not occur in a particular installation. If this equipment does cause harmful interference to radio or television reception, which can be determined by turning the equipment off and on, the user is encouraged to try to correct the interference by one or more of the following measures:

- Reorient or relocate the receiving antenna.
- Increase the separation between the equipment and receiver.
- Connect the equipment into a wall outlet on a circuit different from that to which the receiver is connected.
- Consult the dealer or experienced radio/TV technician for assistance.

B2 Industry Canada Statement

This Class B digital apparatus complies with Canadian ICES-003.

Cet appareil numérique de la classe B est conforme à la norme NMB-003 du Canada.

B3 CE Statement

The EyeMobile Plus complies with the following Directives:

- 93/42/EEC (MDD) - Medical Device Directive, as amended by 2007/47/EC
- 2011/65/EU (RoHS 2) - Restriction of Hazardous Substances Directive
- 2004/108/EC (EMC) - Electromagnetic Compatibility Directive
- 2012/19/EU - WEEE Directive
- 2006/121/EC, 1907/2006/EC Annex 17 - Reach Directive

B4 Other Directives

- Radiocommunication Standard 2008 (ACMA), AS/NZS CISPR 32:2013
- Korean Radio Waves Act, Clause 3, Article 58-2

B5 Standards

The EyeMobile Plus complies with the following standards:

- FCC, CFR Title 47, Part 15 Subpart B: 2015, CLASS B
- ICES-003 Issue 6:2016 Class B
- EN 55032: 2012+AC: 2013 Class B
- EN 55024:2010+A1:2015

- EN 61000-3-2: 2014
- EN 61000-3-3: 2013
- IEC 60950-1:2005
- IEC 60950-1:2005/AMD1:2009
- IEC 60950-1:2005/AMD2:2013

Appendix C Technical Specifications

Technical Specifications	EyeMobile Plus
Gaze Data Rate	60 Hz
Data Streams	Eye tracking (gaze point, eye position, etc.) IR image stream at 30 fps
Power Consumption Full Operation	1.5 W typical average
Processing Unit	Tobii EyeChip™ with fully embedded processing
Interface	USB 2.0 ¹ (power and signal)
Head Movement Box ² size at distance @ 45 cm (@ 17.1") @ 50 cm (@ 19.7") @ 65 cm (@ 25.6") @ 80 cm (@ 31.5")	>20 cm × 20 cm ellipse >7.9" × 7.9" >25 cm × 20 cm ellipse >9.8" × 7.9" >40 cm × 30 cm ellipse >15.7" × 11.8" >35 cm × 35 cm circle >13.8" × 13.8"
Distance from user to the Eye Tracker	45 cm - 80 cm 18" - 33"
User Calibration (former tracking robustness)	>99%
Detected Gaze Interaction >30 Hz Raw data max frame rate	99% for 95% of population ⁴ 90% for 95% of population ⁴
Gaze Accuracy Across 95% of population ³ Across 90% of population ³ Across 80% of population ³ Across 65% of population ³ Ideal ⁴	<1.9° <1.7° <1.3° <1.0° <0.3°
Gaze Precision Across 95% of population ³ Across 90% of population ³ Across 80% of population ³ Across 65% of population ³ Ideal ⁴	<0.4° <0.3° <0.25° <0.2° <0.1°
Max Head Movement Speed Eye Position Gaze Data	40 cm/s (15.7 in/s) 10 cm/s (3.9 in/s)
Max Head Tilt	>20°
Max Yaw, pitch	25°

Technical Specifications	EyeMobile Plus
Visibility	Low visibility (850 nm)
Flicker	no flicker (30 Hz constant)
Data Flow and Data Rate	
Gaze Latency	25 ms
Gaze Recovery	100 ms
Low Resolution Stream	640×480 @30 Hz
Unit Size (Length × Height × Depth)	170 mm × 172 mm × 40 mm 6.7" × 6.8" × 1.6"
Unit Weight	670 g 23.6 oz
Tobii Certified Tablets⁵	Microsoft Surface Pro 4 and Surface Pro
Supported tablet dimensions (Length × Height × Depth)	265-310 mm × 185-205 mm × 8-10 mm 10.4-12.2" × 7.3-8.1" × 0.3-0.4"
Microphone	Microphone array consisting of 4 microphones
Ports	2 × 3.5 mm Switch connector interface 1 × USB 2.0 1 × micro USB 3.0 1 × 5 VDC 4.4 mm Barrel Power Connector
Speakers	2 × 3.5 W
IR Remote Control (Environmental Control Unit)	Learning remote with integrated library of pre-programmed devices
Battery Run Time	> 9 hours. normal usage
Battery Technology	Li-ion Polymer rechargeable battery
Battery Capacity	28 Wh
Battery Charge Time	< 4 hours
Power Supply	5 VDC 3A AC adapter

1. USB2 requirements: USB 2.0 BC1.2 provides Tobii IS4 with sufficient power and signal bandwidth.
2. Head box describes the space in front of the eye tracker where the user must have at least one eye to get gaze data. The eye tracker is at a 20° angle looking upward from below the screen.
3. The degree-of-accuracy and precision over percentage-of-population numbers result from extensive testing across representatives of the whole population. We have made use of hundreds of thousands of diagnostic images and performed tests on approximately 800 individuals with different conditions, vision, ethnicities, everyday dust, smudges or blemishes around their eyes, with eyes out of focus, etc. This has resulted in a much more robust and high performance eye tracking experience and a much more realistic representation of true performance across the whole population, not just in a mathematically "ideal" scenario.
4. The "ideal" degree numbers are the previous standard of measuring accuracy and precision, both previously from Tobii and presently from all eye tracking competitors. Though "ideal" numbers are useful to get a general feel about comparative quality and performance, they are not applicable to real world usage in the same way as quantitative degree-of-accuracy and precision over percentage-of-population numbers based on extensive testing across representatives of the whole population.
5. Other tablets that fulfil the system requirements and supported dimensions might be compatible, as long as the USB port and charging connector is not interfering with the EyeMobile Plus bracket.

Copyright ©Tobii AB (publ). Illustrations and specifications do not necessarily apply to products and services offered in each local market. Technical specifications are subject to change without prior notice. All other trademarks are the property of their respective owners.

Support for Your Tobii Dynavox Device

Get Help Online

See the product-specific Support page for your Tobii Dynavox device. It contains up-to-date information about issues and tips & tricks related to the product. Find our Support pages online at: www.TobiiDynavox.com/support-training

Contact Your Sales Representative or Reseller

For questions or problems with your product, contact your Tobii Dynavox sales representative or authorized reseller for assistance. They are most familiar with your personal setup and can best help you with tips and product training. For contact details, visit www.TobiiDynavox.com/contact